

Alpha-3R Series

Direct Thermal Portable Printer

USER'S MANUAL

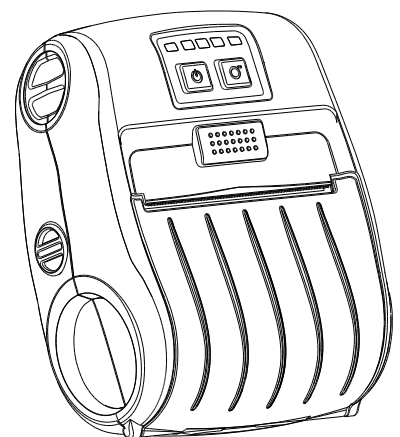

Copyright Information

©2012 TSC Auto ID Technology Co., Ltd,

The copyright in this manual, the software and firmware in the printer described therein are owned by TSC Auto ID Technology Co., Ltd, All rights reserved.

CG Triumvirate is a trademark of Agfa Corporation. CG Triumvirate Bold Condensed font is under license from the Monotype Corporation. Windows is a registered trademark of Microsoft Corporation.

All other trademarks are the property of their respective owners.

Information in this document is subject to change without notice and does not represent a commitment on the part of TSC Auto ID Technology Co. No part of this manual may be reproduced or transmitted in any form or by any means, for any purpose other than the purchaser's personal use, without the expressed written permission of TSC Auto ID Technology Co.



Agency Compliance and Approvals



CE CLASS B
EN 55022:2006 +A1:2007
EN 55024:1998+A1:2001+A2:2003
EN 61000-4 SERIES REGULATIONS



FCC CFR Title 47 Part 15 Subpart B:2011 Class B
ICES-003 Issue 4:2004 Class B



AS/NZS CISPR22---ITE
AS/NZS 4268-----RF(WIFI & BT)
Following standards for SAR(WIFI)
Radio communications (Electromagnetic Radiation — Human Exposure) Standard 2003 Amendment 2011
IEC 62209-2

Wichtige Sicherheits-Hinweise

1. Bitte lesen Sie diese Hinweis sorgfältig durch.
2. Heben Sie diese Anleitung für den späteren Gebrauch auf.
3. Vor jedem Reinigen ist das Gerät vom Stromnetz zu trennen. Verwenden Sie keine Flüssig-oder Aerosolreiniger. Am besten eignet sich ein angefeuchtetes Tuch zur Reinigung.
4. Die Netzanschluß-Steckdose soll nahe dem Gerät angebracht und leicht zugänglich sein.
5. Das Gerät ist vor Feuchtigkeit zu schützen.
6. Bei der Aufstellung des Gerätes ist auf sicheren Stand zu achten. Ein Kippen oder Fallen könnte Beschädigungen hervorrufen.
7. Beachten Sie beim Anschluß ans Stromnetz die Anschlußwerte.
8. Dieses Gerät kann bis zu einer Außentemperatur von maximal 40°C betrieben werden.

Battery safety warning:

- DO NOT throw the battery in fire.
- DO NOT short circuit the contacts.
- DO NOT disassemble the battery.
- DO NOT throw the battery in municipal waste.

The symbol of the crossed out wheeled bin indicates that the battery should not be placed in municipal waste.

"ORSICHT"

Explosionsgefahr bei unsachgemäßen Austausch der Batterie. Ersatz nur durch denselben oder einem vom Hersteller empfohlenen gleichen Typ. Entsorgung gebrauchter Batterien nach Angaben des Herstellers.

Class B:

FEDERAL COMMUNICATIONS COMMISSION INTERFERENCE STATEMENT

This equipment has been tested and found to comply with the limits for a Class B digital device, pursuant to part 15 of the FCC Rules. These limits are designed to provide reasonable protection against harmful interference in a residential installation. This equipment generates, uses and can radiate radio frequency energy and, if not installed and used in accordance with the instructions, may cause harmful interference to radio communications. However, there is no guarantee that interference will not occur in a particular installation. If this equipment does cause harmful interference to radio or television reception, which can be determined by turning the equipment off and on, the user is encouraged to try to correct the interference by one or more of the following measures:

-Reorient or relocate the receiving antenna.

-Increase the separation between the equipment and receiver.

-Connect the equipment into an outlet on a circuit different from that to which the receiver is connected.

-Consult the dealer or an experienced radio/ TV technician for help.

CAUTION:

Any changes or modifications not expressly approved by the grantee of this device could void the user's authority to operate the equipment.

RF exposure warning (WiFi)

This equipment must be installed and operated in accordance with provided instructions and must not be co-located or operating in conjunction with any other antenna or transmitter. End-users and installers must be providing with antenna installation instructions and transmitter operating conditions for satisfying RF exposure compliance.

SAR Value: 0.023 W/kg

RF exposure warning (For Bluetooth)

The equipment complies with FCC RF exposure limits set forth for an uncontrolled environment.

The equipment must not be co-located or operating in conjunction with any other antenna or transmitter.

Canada, Industry Canada (IC) Notices

This Class B digital apparatus complies with Canadian ICES-003 and RSS-210. Operation is subject to the following two conditions: (1) this device may not cause interference, and (2) this device must accept any interference, including interference that may cause undesired operation of the device.

Radio Frequency (RF) Exposure Information

The radiated output power of the Wireless Device is below the Industry Canada (IC) radio frequency exposure limits. The Wireless Device should be used in such a manner such that the potential for human contact during normal operation is minimized.

This device has been evaluated for and shown compliant with the IC Specific Absorption Rate ("SAR") limits when installed in specific host products operated in portable exposure conditions. **(For WiFi)**

This device has also been evaluated and shown compliant with the IC RF Exposure limits under portable exposure conditions. (antennas are less than 20 cm of a person's body). **(For Bluetooth)**

Canada, avis de l'Industry Canada (IC)

Cet appareil numérique de classe B est conforme aux normes canadiennes ICES-003 et RSS-210.

Son fonctionnement est soumis aux deux conditions suivantes : (1) cet appareil ne doit pas causer d'interférence et (2) cet appareil doit accepter toute interférence, notamment les interférences qui peuvent affecter son fonctionnement.

Informations concernant l'exposition aux fréquences radio (RF)

La puissance de sortie émise par l'appareil sans fil est inférieure à la limite d'exposition aux fréquences radio de l'Industry Canada (IC). Utilisez l'appareil sans fil de façon à minimiser les contacts humains lors du fonctionnement normal.

Ce périphérique a été évalué et démontré conforme aux limites SAR (Specific Absorption Rate – Taux d'absorption spécifique) par l'IC lorsqu'il est connecté à des dispositifs hôtes spécifiques opérant dans des conditions d'utilisation mobile. **(Pour le Wi-Fi)**

Ce périphérique a également été évalué et démontré conforme aux limites d'exposition radio-fréquence par l'IC pour des utilisations par des opérateurs mobiles (les antennes sont à moins de 20 cm du corps d'une personne). **(Pour le Bluetooth)**

NCC 警語:

經型式認證合格之低功率射頻電機，非經許可，公司、商號或使用者均不得擅自變更頻率、加大功率或變更原設計之特性及功能。(即低功率電波輻射性電機管理辦法第十二條)

低功率射頻電機之使用不得影響飛航安全及干擾合法通信；經發現有干擾現象時，應立即停用，並改善至無干擾時方得繼續使用。

前項合法通信，指依電信法規定作業之無線電通信。低功率射頻電機須忍受合法通信或工業、科學及醫療用電波輻射性電機設備之干擾。(即低功率電波輻射性電機管理辦法第十四條)

Contents

1. Introduction	1
1.1 Product Introduction	1
1.2 Product Features	2
1.2.1 Printer Standard Features	2
1.2.2 Printer Optional Features	3
1.3 General Specifications	3
1.4 Print Specifications	4
1.5 Media Specifications	4
2. Operations Overview	5
2.1 Unpacking and Inspection	5
2.2 Printer Overview	6
2.2.1 Front View	6
2.2.2 Interior View	7
2.2.3 Rear View	8
2.3 Operator control	9
2.3.1 LED Indication and Keys	9
3. Setup	11
3.1 Install the Battery	11
3.2 Charge the Battery	12
3.2.1 Charge the Battery	12
3.2.2 Charge by Charger Station (Optional)	13
3.2.3 Charge by Vehicle Power Adaptor (Optional)	14
3.3 Communicate	15
3.3.1 Connecting with the Communication Cable	15
3.3.2 Connecting with Bluetooth (Optional)	16
3.4 Loading the Media	17
4. Accessories	19
4.1 Install the Belt Clip	19
4.2 Install the IP54-rated environmental case with shoulder strap (Optional) ..	20
5. Power-on Utilities	21
5.1 Media Sensor Calibration	21
5.2 Self-test and Dump Mode	22
5.3 Printer Initialization	25
6. Diagnostic Tool	26
6.1 Start the Diagnostic Tool	26

6.2 Printer Function	27
6.3 Calibrating Media Sensor by Diagnostic Tool	28
6.3.1 Auto Calibration	28
6.4 Setting Wi-Fi by Diagnostic Tool (Optional)	29
6.5 Setting Bluetooth by Diagnostic Tool (Optional)	30
7. Troubleshooting	31
7.1 Common Problems	31
8. Maintenance	33
Revise History	34

1. Introduction

1.1 Product Introduction

Thank you very much for purchasing TSC bar code printer.

Enjoy TSC's reputation for cost-efficient, high durability printers with the Alpha-3R economical printer. The Alpha-3R is a comfortable, light-weight printer capable of working with any mobile printing application where you need quick, simple receipts/labels on demand.

Our Alpha-3R is designed for a rough life, inside the IP54-rated protective case to resist dust and water and with its rubber over-mold design prepared to take up to a five foot fall and keep printing.

These small and light printers can be worn comfortably for a full shift, without interfering with the user's tasks. Use USB, or optional Bluetooth, 802.11 b/g/n Wireless or Serial to connect to a mobile computer or even a smart phone and produce clear easy-to-read receipts hour after hour.

This document provides an easy reference for operating the Alpha-3R.

The online version of the Programmer's manual, or more information can be downloaded from service and support web site as an Adobe[®] Acrobat[®] Reader file. To print label formats, please refer to the instructions provided with your labeling software; if you need to write the custom programs, please refer to the TSPL/TSPL2 programming manual that can be found on the accessories CD-ROM or on TSC website at <http://www.tscprinters.com>.

– Applications

- Direct store deliveries (DSD)
- Field repair/installation
- Mobile point of sale
- Parking citations
- Mobile ticketing
- Onboard transportation ticketing
- Utility billing/meter reading

1.2 Product Features

1.2.1 Printer Standard Features

The printer offers the following standard features.

Product standard feature		
Direct thermal printing		
Black mark reflective sensor		
Head open sensor		
3 operation buttons (On/off, feed, and cover-open)		
2 color LED for printer status, 3 LEDs for battery status		
USB 2.0 (full speed) interface		
8 MB SDRAM memory		
4 MB FLASH memory		
Powerful 32 bit 200 MHz RISC processor		
Eltron [®] and Zebra [®] emulation languages support		
Internal 8 alpha-numeric bitmap fonts		
Fonts and bar codes can be printed in any one of the four directions (0, 90,180, 270 degree)		
Internal Monotype Imaging [®] true type font engine with one CG Triumvirate Bold Condensed scalable font		
Downloadable fonts from PC to printer memory		
Downloadable firmware upgrades		
Text, bar code, graphics/image printing (Please refer to the TSPL/TSPL2 programming manual for supporting code page)		
Supported bar code		Supported image
1D bar code	2D bar code	BITMAP, BMP, PCX (Max. 256 colors graphics)
Code 39, Code 93, Code128UCC, Code128 subsets A,B,C, Codabar, Interleaved 2 of 5, EAN-8, EAN-13, EAN-128, UPC-A, UPC-E, EAN and UPC 2(5) digits add-on, MSI, PLESSEY, POSTNET, China POST, GS1 DataBar,	PDF-417, Maxicode, DataMatrix, QR code, Aztec,	

1.2.2 Printer Optional Features

The printer offers the following optional features.

Product option feature	User options	Factory options
802.11 b/g/n wireless		<input type="radio"/>
Bluetooth 2.0		<input type="radio"/>
CPCL emulation		<input type="radio"/>
Black mark sensor position (left / right / center)		<input type="radio"/>
Charge station 1 cell (with changeable power connector)	<input type="radio"/>	
Vehicle power adapter	<input type="radio"/>	
IP54-rated environmental case with shoulder strap	<input type="radio"/>	
USB to RS-232 cable	<input type="radio"/>	
USB cable	<input type="radio"/>	
Li-ion battery	<input type="radio"/>	

1.3 General Specifications

General Specifications	
Physical dimensions	116 mm (W) x 148 mm (H) x 70 mm (D)
Enclosure	Plastic enclosure with rubber over-mold construction
Weight	550 g (1.21 lb)
Electrical	DC 7.4V/ 2500 mA/ h rechargeable battery
Environmental condition	Operation: -10 ~ 50 °C (14 ~ 122 °F), 10 ~ 90% non-condensing Storage: -40 ~ 60 °C (-40 ~ 140 °F), 10 ~ 90% non-condensing

1.4 Print Specifications

Print Specifications	Alpha-3R
Print head resolution	203 dots/inch (8 dots/mm)
Printing method	Direct thermal
Dot size (width x length)	0.125 x 0.125 mm (1 mm = 8 dots)
Print speed (inches per second)	2, 3, 4 ips selectable Up to 4 ips
Max. print width	72 mm (2.83")
Max. print length	2286 mm (90")
Printout bias	Vertical: 1 mm max. Horizontal: 1 mm max.

1.5 Media Specifications

Media Specifications	Alpha-3R
Media roll capacity	Receipt: 57 mm (2.25") OD Label: 55 mm (2.16") OD
Media type	Receipt paper, Bline receipt paper (Black mark in printing side) & Selected label
Media wound type	Printing face outside wound
Media width	Receipt: 2" ~ 3.15" Label: 2" ~ 3.07"
Media thickness	Receipt: 0.0508 ~ 0.1016 mm (2 ~ 4 mil) Label: Fasson standard label media up to 0.14 mm (5.5 mil)
Media height	Label: Min. 25.4 mm (1")
Media core diameter	10.2 ~ 25.4 mm (0.4" ~ 1")

2. Operations Overview

2.1 Unpacking and Inspection

This printer has been specially packaged to withstand damage during shipping. Please carefully inspect the packaging and printer upon receiving the bar code printer. Please retain the packaging materials in case you need to reship the printer.

Unpacking the printer, the following items are included in the carton.

- One printer unit
- One Li-ion battery
- One Windows labeling software/Windows driver CD disk
- One quick installation guide
- One power adaptor
- One belt clip

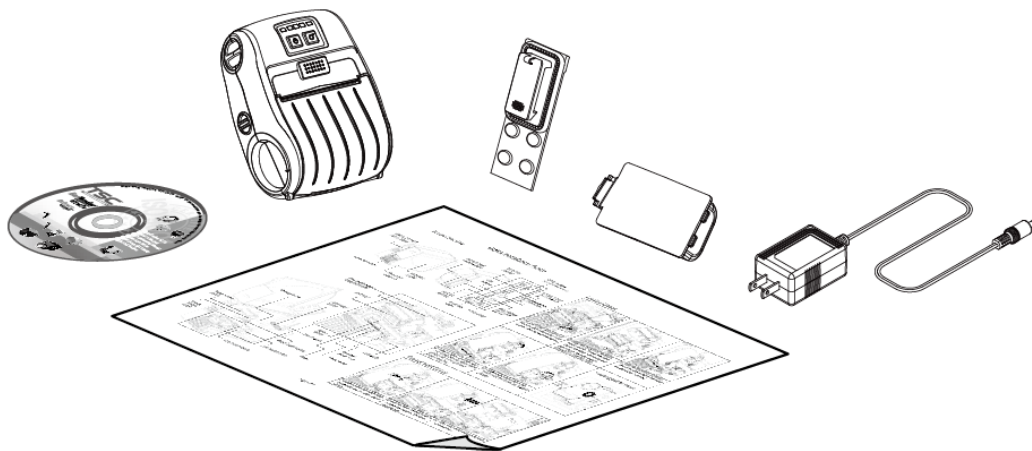

If any parts are missing, please contact the Customer Service Department of your purchased reseller or distributor.

2.2 Printer Overview

2.2.1 Front View

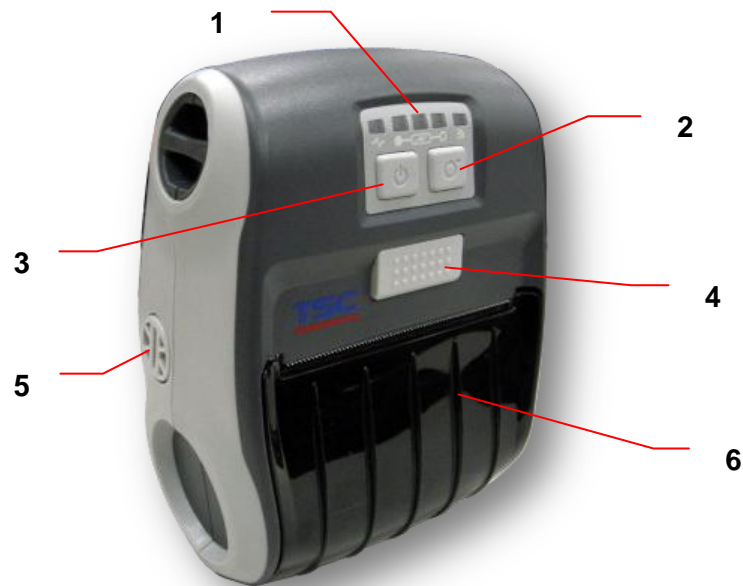

1. LED indicator
2. Feed button
3. Power on/off button
4. Media cover release button
5. Media holder adjustment knob
6. Media cover

2.2.2 Interior View

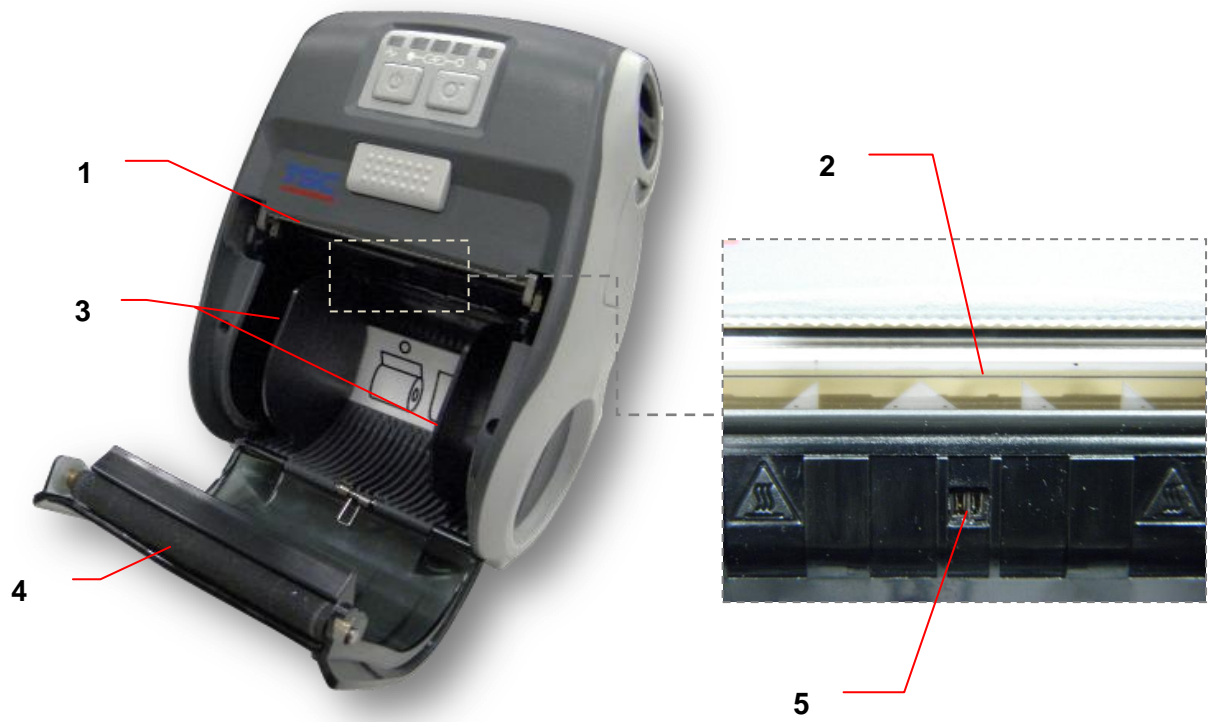

1. Tear edge
2. Print head
3. Media holder
4. Platen
5. Black mark sensor

2.2.3 Rear View

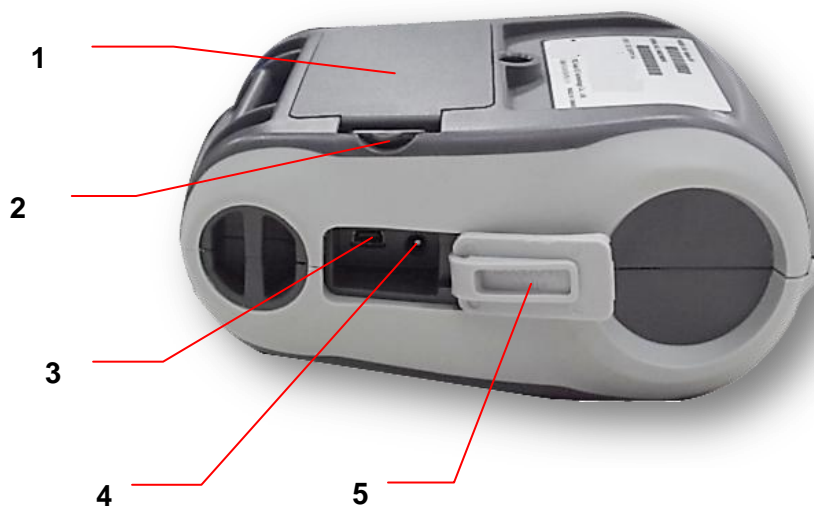

1. Li-ion battery
2. Battery open clasp
3. USB interface
4. Power jack
5. Interface cover

2.3 Operator control

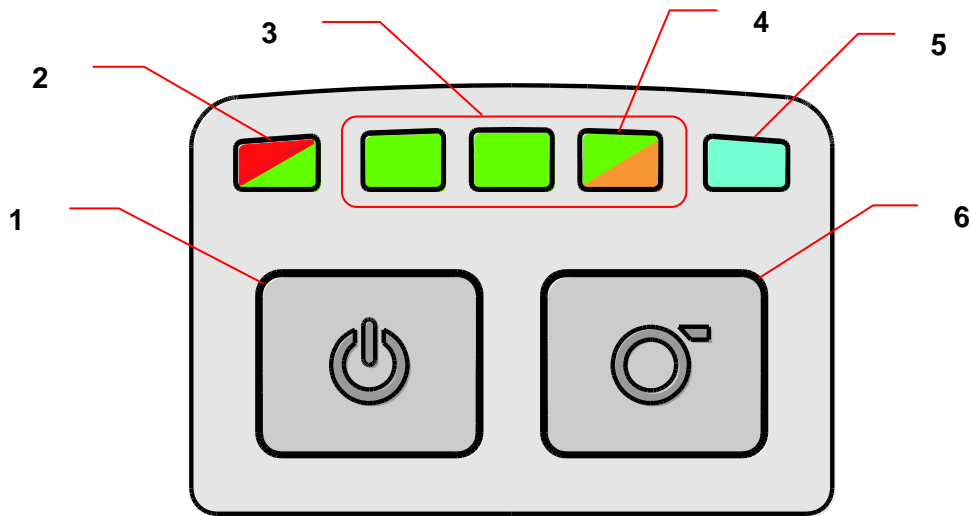

2.3.1 LED Indication and Keys



1. Power on/off button
2. Printer status LED indicator
3. Battery charge level LED indicator
4. Battery status LED indicator
5. Wireless status LED indicator
6. Feed button



LED	Status	Indication
Printer status LED indicator	Off	Printer is ready
	Green (blinking)	Printer is paused
	Red (solid)	Media cover is open
	Red (blinking)	Printer error
Battery status LED indicator	Green (blinking)	Recharge the battery
	Amber (solid)	Battery is charging
Battery charge level LED indicator	Green (solid)	<input type="checkbox"/> <input checked="" type="checkbox"/> <input checked="" type="checkbox"/> <input checked="" type="checkbox"/> <input type="checkbox"/> Full charged
		<input type="checkbox"/> <input type="checkbox"/> <input checked="" type="checkbox"/> <input checked="" type="checkbox"/> <input type="checkbox"/> 2/3 charged level
		<input type="checkbox"/> <input type="checkbox"/> <input type="checkbox"/> <input checked="" type="checkbox"/> <input type="checkbox"/> 1/3 charged level
Wireless status LED indicator	Blue (solid)	Wireless device is ready
	Blue (blinking)	Wireless device is communicating

Note: Wireless module is optional for Alpha-3R model.

Keys	Function
	<ol style="list-style-type: none">1. Press and hold for 2-3 seconds to turn on the printer.2. Press and hold for 2-3 seconds to turn off the printer.
	<ol style="list-style-type: none">1. Ready status: Feed one label2. Printing status: Pause the print job

3. Setup

3.1 Install the Battery

	<p>1. Insert the left side to install the battery at the rear of the printer.</p>
	<p>2. Push the right side of the battery.</p>
	<p>3. Pull the battery clasp to lock the battery.</p>

Battery safety warning:

DO NOT throw the battery in fire. **DO NOT** short circuit the contacts.

DO NOT disassemble the battery. **DO NOT** throw the battery in municipal waste.

The symbol of the crossed out wheeled bin indicates that the battery should not be placed in municipal waste.

3.2 Charge the Battery

It takes 2 to 3 hours to fully charge the battery before the first time usage. The lifetime of the battery is 300 times for charge/discharge cycles.

3.2.1 Charge the Battery



1. Open the interface cover and plug the power cord to the power jack.



2. Plug the power cord into a properly power outlet.

Note:

Please switch OFF printer power prior to plug in the power cord to printer power jack.

When the battery is charging, please do not remove the battery from the printer, otherwise, please re-plug the power cord into a power outlet.

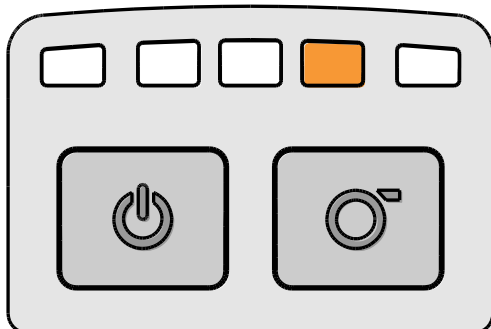

3. When the battery is charging, the color of battery status LED indicator is solid amber.

Note:

When charging over 4 ~ 8 hrs, the battery is completely charged and the amber of LED indicator will be off.

3.2.2 Charge by Charger Station (Optional)

	<p>1. Plug the power cord to the power jack on the charger station.</p>
	<p>2. Install the battery in the charger station. (Refer to steps on section 3.1)</p>
	<p>3. Plug the power cord into a properly power outlet.</p> 

LED Color	Description
Green / Solid	Battery is completely charged
Red / Solid	Battery is charging
Red / Blinking	Battery charging error
Off	No battery
	Battery is completely charged over 4 ~ 8 hrs.

3.2.3 Charge by Vehicle Power Adaptor (Optional)



1. Open the interface cover and plug the power cord to the power jack.





2. Plug the vehicle power adaptor into the car cigarette lighter socket.

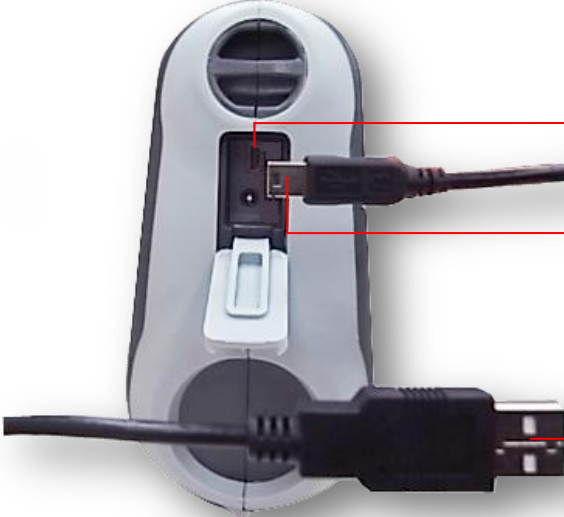

3.3 Communicate

3.3.1 Connecting with the Communication Cable

* USB to USB Cable (Optional)

 <p>The diagram shows the back of a printer with its interface cover open. A USB cable is plugged into the printer's USB port. Another USB cable is plugged into the PC's USB port. Red lines point from the labels to the respective ports.</p>	<p>Open the interface cover and connect the printer to the computer with USB cable.</p> <p>USB interface</p> <p>USB connector (Printer)</p> <p>USB connector (PC)</p> 
---	---

* USB to RS-232 Cable (Optional)

 <p>The diagram shows the back of a printer with its interface cover open. A USB cable is plugged into the printer's USB port. An RS-232 cable is plugged into the PC's RS-232 port. A red line points from the label to the PC's RS-232 port.</p>	<p>Open the interface cover and connect the printer to the computer with RS-232 cable.</p> <p>RS-232 connector (PC)</p> 
---	---

3.3.2 Connecting with Bluetooth (Optional)

<table border="1"><thead><tr><th colspan="2">Default</th></tr></thead><tbody><tr><td>Name</td><td>BT-SPP</td></tr><tr><td>PIN</td><td>0000</td></tr></tbody></table>	Default		Name	BT-SPP	PIN	0000	<p>Turn on the printer and make sure the Bluetooth of device is open.</p> <p>Note: Please refer to section 6.5 to change the name of default and PIN.</p>
Default							
Name	BT-SPP						
PIN	0000						

3.4 Loading the Media



1. Open the printer media cover by pressing the media cover release button.



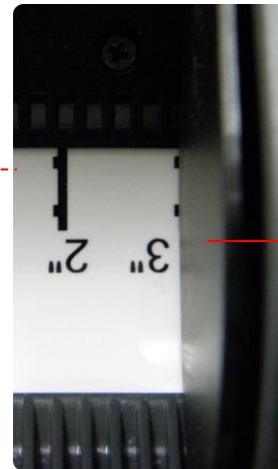

2. Use a coin to rotate the media holder adjustment knob, and the media holder should be placed at the correct place to fit the media roll.

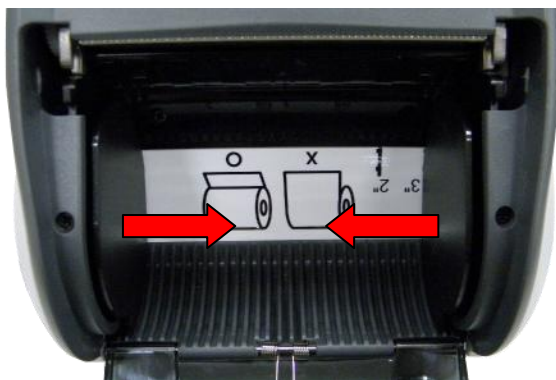

Media holder



Note:
The media holder should be positioned overlap the bold line and remain the media holder alignment indicator visible.

	<p>3. Place the media roll at the correct side, and pull out enough paper over the tear edge.</p>
	<p>4. Press each side of media cover to close the media cover and make sure the media cover closed correctly.</p>

4. Accessories

4.1 Install the Belt Clip



1. Refer to figure beside. Loop the belt clip through the slot below the battery.



2. Fasten the belt clip with 2 buttons.



3. The printer can be hung on the belt.

4.2 Install the IP54-rated environmental case with shoulder strap (Optional)





 <p>Top cover</p>	<p>1. Open the case top cover.</p>
	<p>2. Put the printer into the case.</p>
 <p>Outside cover</p>	<p>3. Close the case top cover. And the outside cover should be opened while printing.</p>

5. Power-on Utilities

There are three power-on utilities to set up and test printer hardware. These utilities are activated by pressing FEED button(Ⓞ) then turning on the printer power simultaneously and release the button at different positions of LED indicator.

Please follow the steps below for different power-on utilities.





1. Turn off the printer power switch.
2. Hold on the FEED button(Ⓞ) then turn on the power switch.
3. Release the button(Ⓞ) when LED indicates with different positions for different functions.

<i>Power on utilities</i>	The positions of LED light will be changed as following pattern:				
<i>LED</i>					
<i>Functions</i>	(Solid)	(5 blinks)	(5 blinks)	(5 blinks)	(Solid green)
1. Media sensor calibration		<i>Release</i>			
2. Self-test and enter dump mode			<i>Release</i>		
3. Printer initialization				<i>Release</i>	

5.1 Media Sensor Calibration

Please follow the steps below to calibrate the media sensor.

1. Turn off the power switch.
2. Hold on the FEED button(Ⓞ) then turn on the power switch.
3. Release the FEED button(Ⓞ) when the indicator becomes  and blinking. (Any green will do during the 5 blinks)





- It will calibrate the black mark sensor sensitivity.
- The LEDs will be changed as following order:
 (amber) →  (**5 blinks**) →  (5 blinks) →  (5 blinks) →  (solid green)

5.2 Self-test and Dump Mode

Please follow the steps below.

1. Turn off the power switch.
2. Hold on the FEED button(Ⓞ) then turn on the power switch.
3. Release the FEED button(Ⓞ) when the indicator becomes  and blinking. (Any green will do during the 5 blinks)

■ The LEDs will be changed as following order:

 (amber) →  (5 blinks) →  **(5 blinks)** →
 (5 blinks) →  (solid green)

4. It calibrates the sensor and measures the media length and prints internal settings then enter the dump mode.
5. Turn off / on the power to resume printer for normal printing.

■ Self-test

Printer will print the printer configuration after media sensor calibration. Self-test printout can be used to check if there is any dot damage on the heater element, printer configurations and available memory space.

<pre> PRINTER INFO. Alpha-3R Version: X.XX EZ SERIAL NO.: MILAGE(m): 3 CHECKSUM: 06ED39DE SERIAL PORT: 9600,N,8,1 CODE PAGE: 850 COUNTRY CODE: 001 SPEED: 2 INCH DENSITY: 12.0 SIZE: 2.83 , 2.00 BLINE: 0.00 , 0.00 TRANSPARENCY: 5 VOLTAGE: 8.22 V TEMPERATURE: 27 °C RESISTANCE: 172 ohm BAD DOT(S): 0 ***** BT ADDRESS: 00190EA0045A BT NAME: BT-SPP BT PIN CODE: 0000 ***** FILE LIST: DRAM FILE: 0 FILE(S) FLASH FILE: 0 FILE(S) PHYSICAL DRAM: XXXX KBYTES AVAILABLE DRAM: XXX KBYTES FREE PHYSICAL FLASH: XXXX KBYTES AVAILABLE FLASH: XXXX KBYTES FREE END OF FILE LIST ***** </pre>	<ul style="list-style-type: none"> Printer model name & Main board firmware version Printer serial number Printed mileage Main board firmware checksum Serial port setting Code page Country code Print speed Print darkness Label size (width, height) Black mark (vertical gap, offset) Sensor sensitivity Battery voltage Print head temperature Print head average resistance Bad dots of print head <ul style="list-style-type: none"> Bluetooth settings information (option) <ul style="list-style-type: none"> File management information <ul style="list-style-type: none"> Print head test pattern
---	---

■ Dump mode

Printer will enter dump mode after printing printer configuration. In the dump mode, all characters will be printed in 2 columns as following. The left side characters are received from your system and right side data are the corresponding hexadecimal value of the characters. It allows users or engineers to verify and debug the program.

	SPEED 2.0	53 50 45 45 44 20 32 2E 30 0D	
	DENSITY 8	0A 44 45 4E 53 49 54 59 20 38	
	SET PEEL	0D 0A 53 45 54 20 50 45 45 4C	
	OFF DIRE	20 4F 46 46 0D 0A 44 49 52 45	
	CTION 0 G	43 54 49 4F 4E 20 30 0D 0A 47	
	AP 3.00 mm	41 50 20 33 2E 30 30 20 6D 6D	
	.0 00 mm	2C 30 2E 30 30 20 6D 6D 0D 0A	
	REFERENCE	52 45 46 45 52 45 4E 43 45 20	
	0.0 SET C	30 2C 30 0D 0A 53 45 54 20 43	
ASCII Data	UTTER OFF	55 54 54 45 52 20 4F 46 46 0E	Hex decimal data related to left column of ASCII data
	SIZE 100.	0A 53 49 5A 45 20 31 30 30 2E	
	02 mm .65.0	30 32 20 6D 6D 2C 36 35 2E 30	
	4 mm .CLS	34 20 6D 6D 0D 0A 43 4C 53 0D	
	BARCODE 1	0A 42 41 52 43 4F 44 45 20 31	
	44.149. *39	34 34 2C 31 34 39 2C 22 33 39	
	. 120.1.0.	22 2C 31 32 30 2C 31 2C 30 2C	
	2.6. *57114	32 2C 36 2C 22 35 37 31 31 34	
	38T* PRIN	33 38 54 22 0D 0A 50 52 49 4E	
	T 1.1 SPE	54 20 31 2C 31 0D 0A 53 50 45	
	ED 2.0 DE	45 44 20 32 2E 30 0D 0A 44 45	
	NSITY 8 S	4E 53 49 64 59 20 38 0D 0A 53	
	ET PEEL OF	45 54 20 50 45 45 4C 20 4F 46	
	F DIRECTI	46 0D 0A 44 49 52 45 43 54 49	
	ON 0 GAP	4F 4E 20 30 0D 0A 47 41 50 20	
	3.00 mm.0.	33 2E 30 30 20 6D 6D 2C 30 2E	
	00 mm REF	30 30 20 6D 6D 0D 0A 52 45 46	
	ERENCE 0.0	45 52 45 4E 43 45 20 30 2C 30	
	SET CUTT	0D 0A 53 45 54 20 43 55 54 54	
	ER OFF SI	45 52 20 4F 46 46 0D 0A 53 49	
	ZE 100.02	5A 45 20 31 30 30 2E 30 32 20	
	mm.65.04 m	6D 6D 2C 36 35 2E 30 34 20 6D	
	m .CLS BA	6D 0D 0A 43 4C 53 0D 0A 42 41	
	RCODE 144.	52 43 4F 44 45 20 31 34 34 2C	
	149. *39* 1	31 34 39 2C 22 33 39 22 2C 31	
	20.1.0.2.6	32 30 2C 31 2C 30 2C 32 2C 36	
	* 5711438T	2C 22 35 37 31 31 34 33 38 54	
	* PRINT 1	22 0D 0A 50 52 49 4E 54 20 31	
	.1	2C 31 0D 0A	

Note:





1. Dump mode requires 3" wide paper width.
2. Turn off / on the power to resume printer for normal printing.

5.3 Printer Initialization

Printer initialization is used to clear DRAM and restore printer settings to defaults. Printer initialization is activated by the following procedures.

1. Turn off the power switch.
2. Hold on the FEED button(⊙) then turn on the power switch.
3. Release the FEED button(⊙) when the indicator becomes  and blinking. (Any green will do during the 5 blinks).

■ The LEDs will be changed as following:

 (amber) →  (5 blinks) →  (5 blinks) →  (5 blinks) →  (solid green)

Printer configuration will be restored to defaults as below after initialization.

Parameter	Default setting
Speed	50.8 mm/sec (2 ips)
Density	8
Media Width	2.83" (72 mm)
Media Height	4" (101.5 mm)
Sensor Type	Black mark sensor (As paper end sensor)
Black Mark Setting	As paper end sensor
Print Direction	0
Reference Point	0,0 (upper left corner)
Offset	0
Serial Port Settings	9600 bps, none parity, 8 data bits, 1 stop bit
Code Page	850
Country Code	001
Clear Flash Memory	No
IP Address	DHCP

6. Diagnostic Tool

TSC's Diagnostic Utility is an integrated tool incorporating features that enable you to explore a printer's settings/status; change a printer's settings; download graphics, fonts and firmware; create a printer bitmap font; and send additional commands to a printer. With the aid of this powerful tool, you can review printer status and settings in an instant, which makes it much easier to troubleshoot problems and other issues.

6.1 Start the Diagnostic Tool

1. Double click on the Diagnostic tool icon  `DiagTool.exe` to start the software.
2. There are four features (Printer Configuration, File Manager, Bitmap Font Manager, Command Tool) included in the Diagnostic utility.

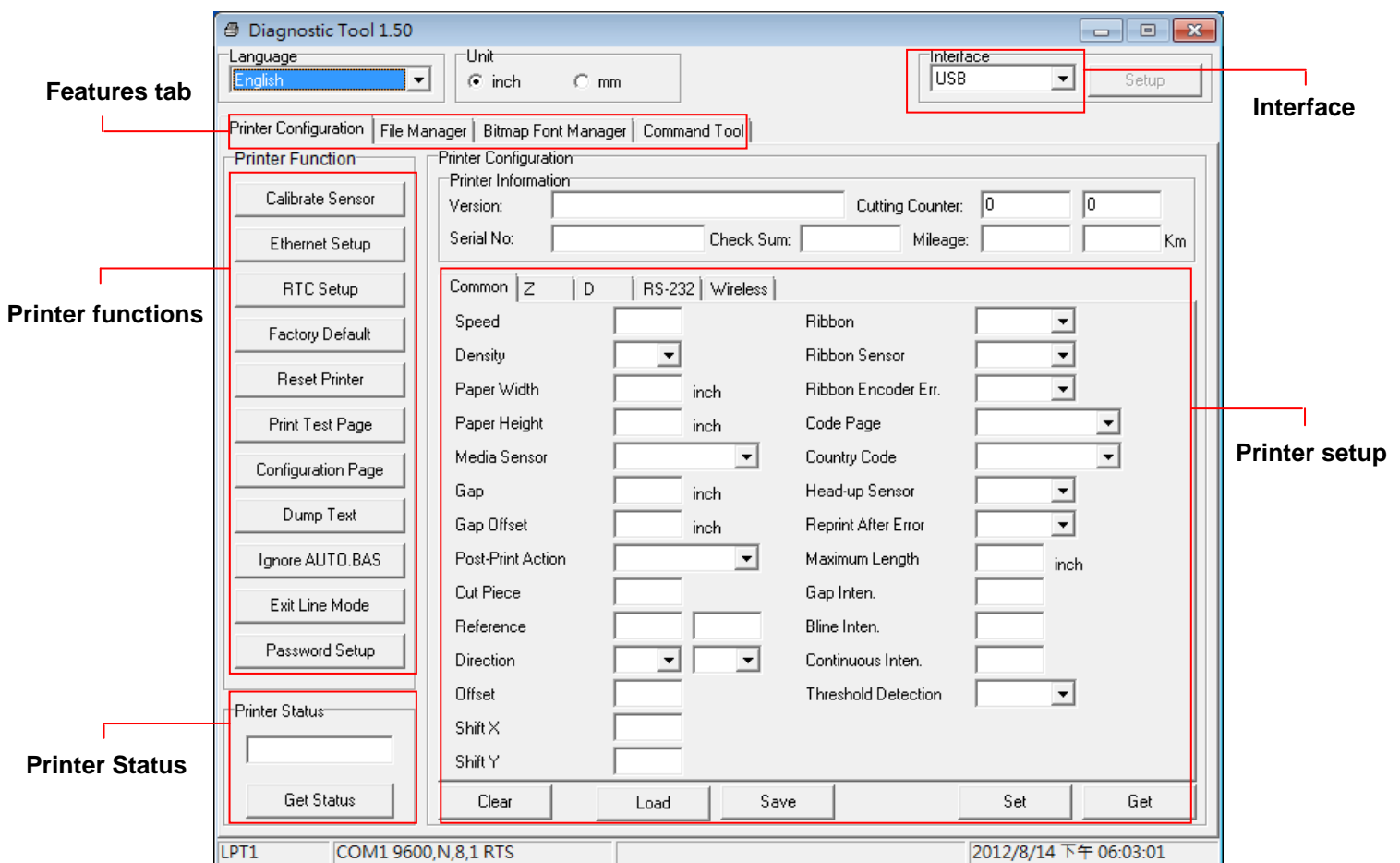

6.2 Printer Function

1. Select the PC interface connected with bar code printer.

The default interface setting is USB interface. If USB interface is connected with printer, no other settings need to be changed in the interface field.

2. Click the “Printer Function” button to setup.
3. The detail functions in the Printer Function Group are listed as below.

Printer Function	Function	Description
Calibrate Sensor	Calibrate Sensor	Calibrate the sensor specified in the Printer Setup group media sensor field
Ethernet Setup	Ethernet Setup	Setup the IP address, subnet mask, gateway for the on board Ethernet
RTC Setup	RTC Setup	Synchronize printer Real Time Clock with PC
Factory Default	Factory Default	Initialize the printer and restore the settings to factory default. (Please refer section 5.3)
Reset Printer	Reset Printer	Reboot printer
Print Test Page	Print Test Page	Print a test page
Configuration Page	Configuration Page	Print printer configuration (Please refer section 5.2)
Dump Text	Dump Text	To activate the printer dump mode.
Ignore AUTO.BAS	Ignore AUTO.BAS	Ignore the downloaded AUTO.BAS program
Exit Line Mode	Exit Line Mode	Exit line mode.
Password Setup	Password Setup	Set the password to protect the settings

For more information about Diagnostic Tool, please refer to the diagnostic utility quick start guide in the CD disk \ Utilities directory.

6.3 Calibrating Media Sensor by Diagnostic Tool

6.3.1 Auto Calibration

1. Make sure the media is installed ready and media cover is closed. (Please refer to section 3.4)
2. Turn on the printer power switch.
3. Open Diagnostic tool and set interface. (The default setting is USB)

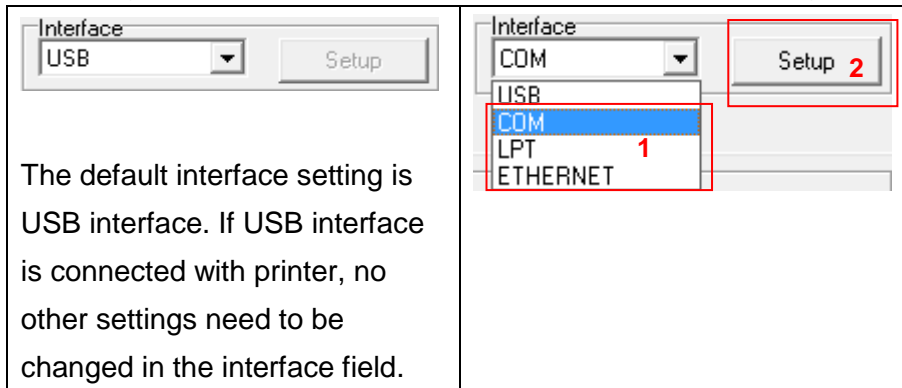

4. Click the “Calibrate Sensor” button.
5. Select the media type and click the “Calibrate” button.

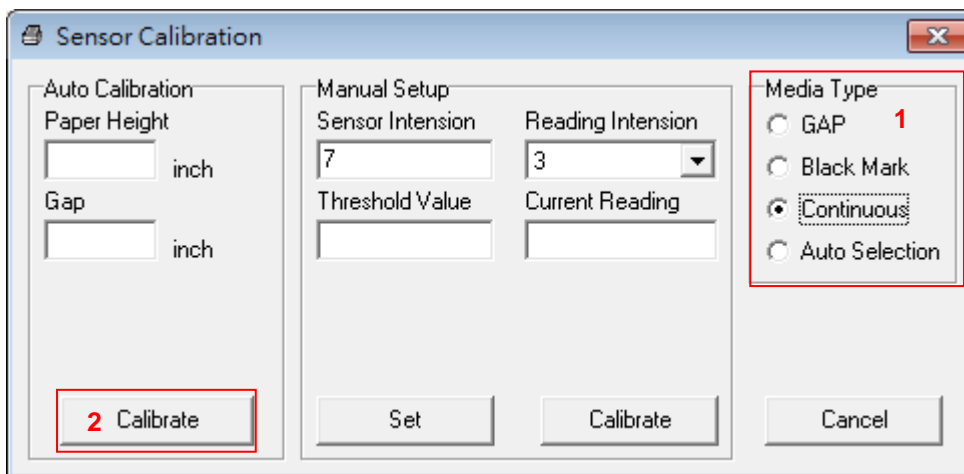

Note:

The Alpha-3R can only support black mark and continuous of media type.

6.4 Setting Wi-Fi by Diagnostic Tool (Optional)

1. Make sure the media is installed ready and media cover is closed. (Please refer to section 3.4)
2. Turn on the printer power switch.
3. Open Diagnostic tool and set interface. (The default setting is USB)

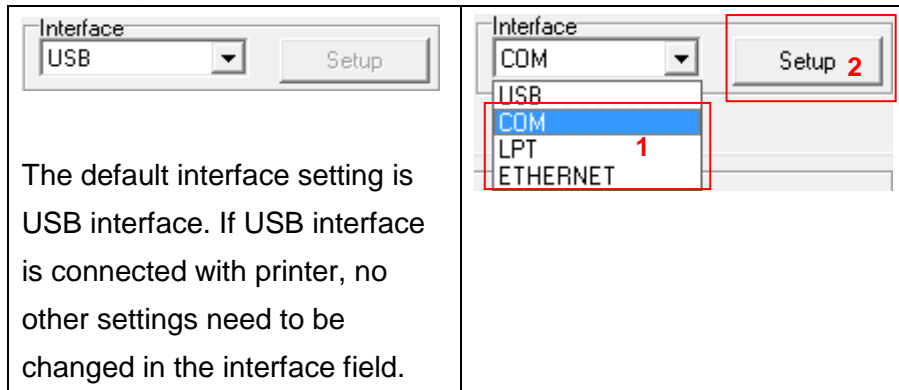

4. Select “Wireless” tab and “Built-in wireless module” item.
5. Enter and select the new WLAN settings in the editor.
6. Press “Set” button to set the new settings to the printer.
7. Press “Get” button to make sure WLAN is set properly.

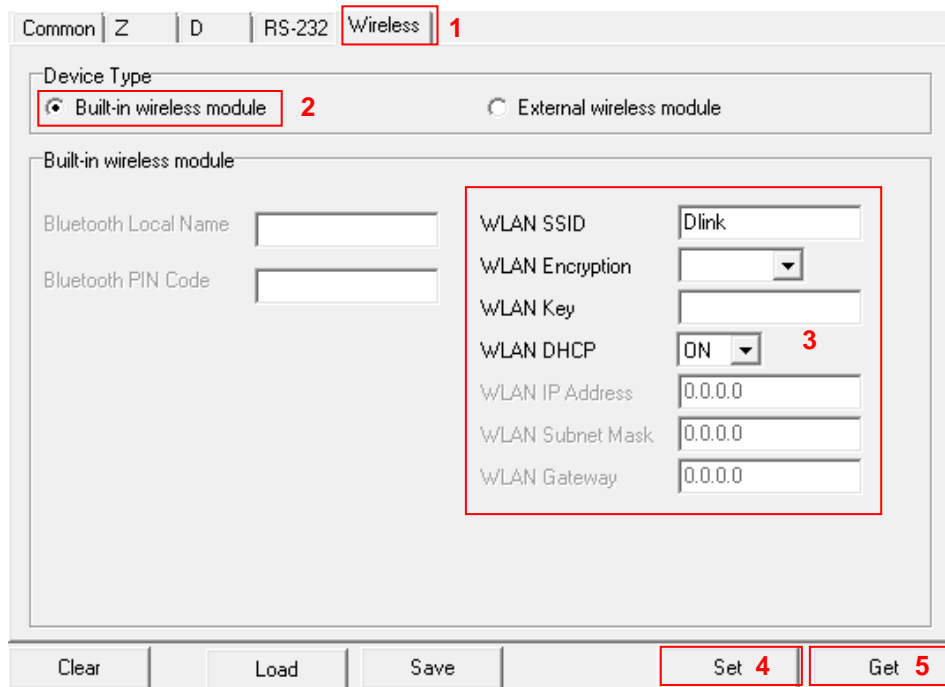

Note:

- * The printer connects with the computer via USB cable or RS-232 cable, which are option.
- * Diagnostic tool higher than V1.50 and the firmware higher than V1.22 can support this function.

6.5 Setting Bluetooth by Diagnostic Tool (Optional)

1. Make sure the media is installed ready and media cover is closed. (Please refer to section 3.4)
2. Turn on the printer power switch.
3. Open Diagnostic tool and set interface. (The default setting is USB)

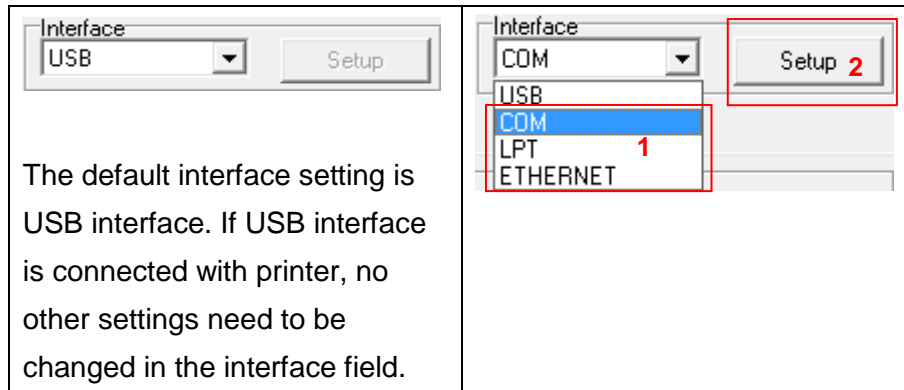

4. Select “Wireless” tab and “Built-in wireless module” item.
5. Enter the new BT Local Name or BT PIN Code in the editor.
6. Press “Set” button to set the new BT name or BT PIN code of the printer.
7. Press “Get” button to get back the settings. Make sure the Bluetooth module settings are set properly.

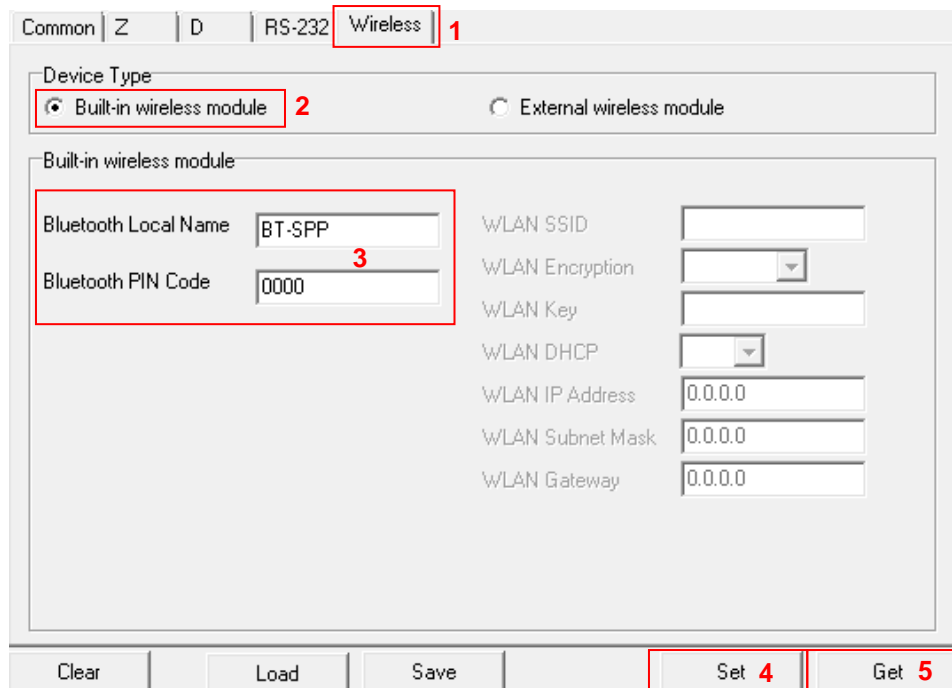

Note:

- * The printer connects with the computer via USB cable or RS-232 cable, which are option.
- * Diagnostic tool higher than V1.50 and the firmware higher than V1.22 can support this function.

7. Troubleshooting

7.1 Common Problems

The following guide lists the most common problems that may be encountered when operating this bar code printer. If the printer still does not function after all suggested solutions have been invoked, please contact the Customer Service Department of your purchased reseller or distributor for assistance.

Problem	Possible Cause	Recovery Procedure
Power indicator does not illuminate	<ul style="list-style-type: none"> * The battery is not properly installed. * The battery is dead. 	<ul style="list-style-type: none"> * Reinstall the battery. * Switch the printer on. * Charge the battery.
- The printer status from DiagTool shows “ Head Open ”.	<ul style="list-style-type: none"> * The printer carriage is open. 	<ul style="list-style-type: none"> * Please close the print carriage.
- The printer status from DiagTool shows “ Out of Paper ”..	<ul style="list-style-type: none"> * Running out of media roll. * The media is installed incorrectly. * Black mark sensor is not calibrated. 	<ul style="list-style-type: none"> * Supply a new media roll. * Please refer to the steps on section 3.4 to reinstall the media roll. * Calibrate the black mark sensor.
- The printer status from DiagTool shows “ Paper Jam ”.	<ul style="list-style-type: none"> * Black mark sensor is not set properly. * Make sure media size is set properly. * Media may be stuck inside the printer mechanism. 	<ul style="list-style-type: none"> * Calibrate the black mark sensor. * Set media size correctly.
Memory full (FLASH / DRAM)	<ul style="list-style-type: none"> * The space of FLASH/DRAM is full. 	<ul style="list-style-type: none"> * Delete unused files in the FLASH/DRAM. * The max. numbers of DRAM is 256 files. * The max. user addressable memory space of DRAM is 256KB. * The max. numbers of file of FLASH is 256 files. * The max. user addressable memory space of FLASH is 2560KB.
Poor Print Quality	<ul style="list-style-type: none"> * Media is loaded incorrectly * Dust or adhesive accumulation on the print head. * Print density is not set properly. * Printhead element is damaged. 	<ul style="list-style-type: none"> * Reload the supply. * Clean the print head. * Clean the platen roller. * Adjust the print density and print speed. * Run printer self-test and check the print head test pattern if there is dot missing in the pattern. * Change proper media roll.
Missing printing on the left or right side of label	<ul style="list-style-type: none"> * Wrong label size setup. 	<ul style="list-style-type: none"> * Set the correct label size.
Gray line on the blank label	<ul style="list-style-type: none"> * The print head is dirty. * The platen roller is dirty. 	<ul style="list-style-type: none"> * Clean the print head. * Clean the platen roller.

Irregular printing	* The printer is in Hex Dump mode. * The RS-232 setting is incorrect.	* Turn off and on the printer to skip the dump mode. * Re-set the Rs-232 setting.
---------------------------	--	--

8. Maintenance

This session presents the clean tools and methods to maintain your printer.

1. Please use one of following material to clean the printer.

- Cotton swab
- Lint-free cloth
- Vacuum / Blower brush
- 100% Ethanol or Isopropyl Alcohol

2. The cleaning process is described as following,

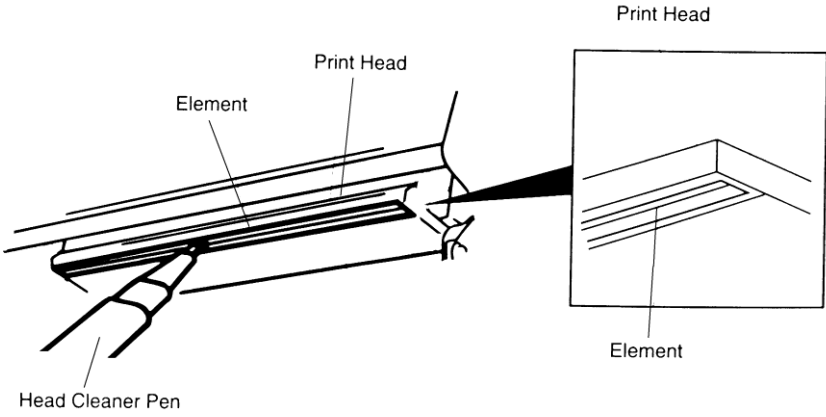
Printer Part	Method	Interval
Print Head	1. Always turn off the printer before cleaning the print head. 2. Allow the print head to cool for a minimum of one minute. 3. Use a cotton swab and 100% Ethanol or Isopropyl Alcohol to clean the print head surface.	Clean the print head when changing a new label roll
		
Platen Roller	1. Turn the power off. 2. Rotate the platen roller and wipe it thoroughly with water.	Clean the platen roller when changing a new label roll
Tear Bar/Peel Bar	Use the lint-free cloth with 100% ethanol to wipe it.	As needed
Sensor	Compressed air or vacuum	Monthly
Exterior	Wipe it with water-dampened cloth	As needed
Interior	Brush or vacuum	As needed

Note:

- Do not touch printer head by hand. If you touch it careless, please use ethanol to clean it.
- Please use 100% Ethenol or Isopropyl Alcohol. DO NOT use medical alcohol, which may damage the printer head.
- Regularly clean the print head and supply sensors once change a new ribbon to keep printer performance and extend printer life.

Revise History

Date	Content	Editor
2013/4/3	Add standards for C-Tick	Camille
2013/5/14	Modify the section 1.3	Camille
2013/5/24	Modify the section 1.5	Camille
2013/8/26	Update pictures for Alpha-3R	Camille
2013/11/12	Modify section 1.1 Modify section 1.5	Camille



TSC Auto ID Technology Co., Ltd.

Corporate Headquarters

9F., No.95, Minguan Rd., Xindian Dist.,
New Taipei City 23141, Taiwan (R.O.C.)
TEL: +886-2-2218-6789
FAX: +886-2-2218-5678

Web site: www.tscprinters.com

E-mail: printer_sales@tscprinters.com
tech_support@tscprinters.com

Li Ze Plant

No.35, Sec. 2, Ligong 1st Rd., Wujie Township,
Yilan County 26841, Taiwan (R.O.C.)
TEL: +886-3-990-6677
FAX: +886-3-990-5577